

BLECAC5 RGBW BLE Controller (5-wire)

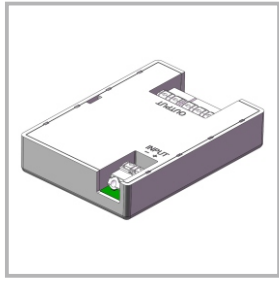

BLE Controller

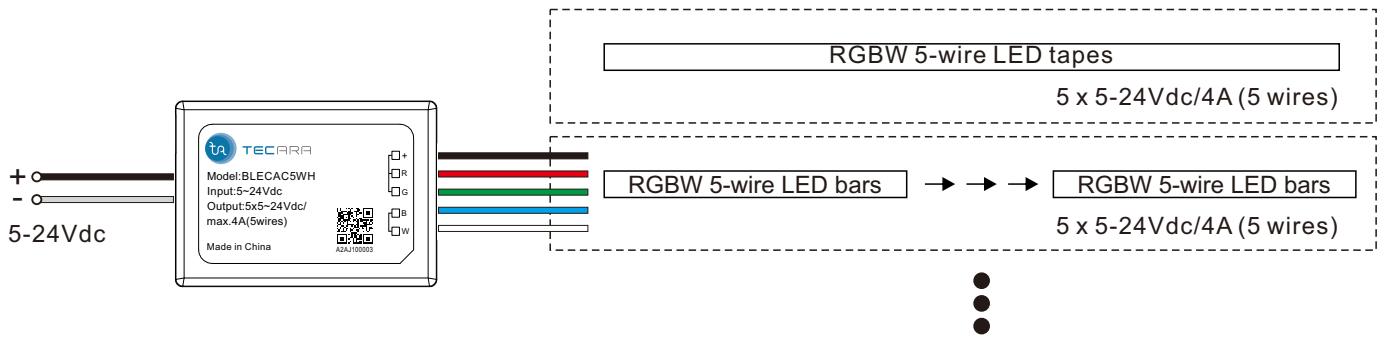
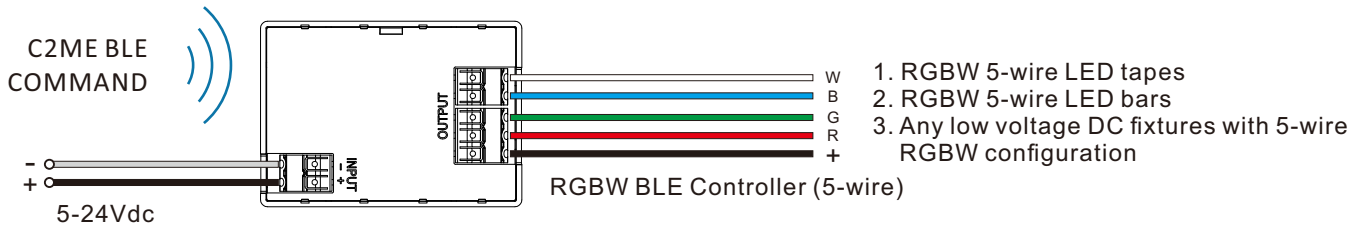
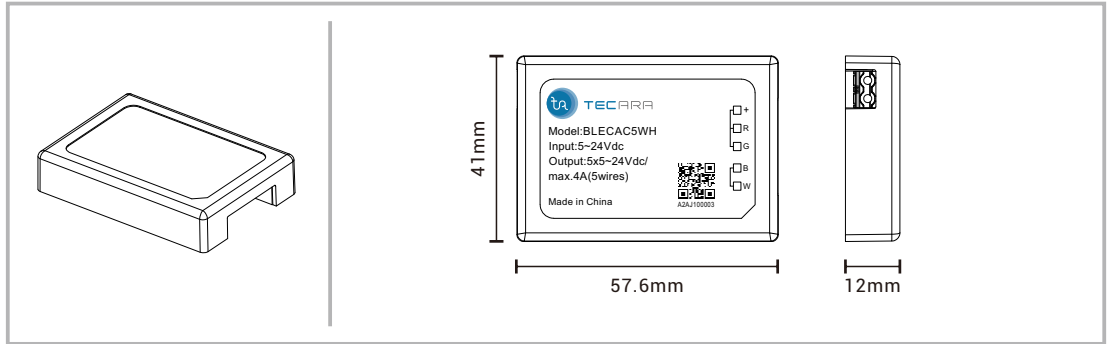

Remark:

This controller takes a 5-24Vdc input and converts it into 5 x 5-24Vdc (4A) outputs to a 5-wire RGBW fixture in order to support a BLE wireless ON/OFF, dimming, CCT and color control.

Technical Specs:

Input: 5-24Vdc
Output: 5 x 5-24Vdc/4A (5 wires)

Applications:

- RGBW 5-wire LED tapes
- RGBW 5-wire LED bars
- Any low voltage DC fixtures with 5-wire RGBW configuration

Ordering Codes

Follow the steps to specify your fixture.

example:

① Base Code	② Code	Color
BLECAC5	WH	White
	BK	Black